

PROJECT: TYPE:

LOCATION: CAT:



Description

A low-voltage, flat panel LED luminaire.

Features

- 3000K CCT
- Slim design allows for easy installation and integration into environment
- Low-profile (less than 3/8" high)
- Inter-connectable via included end-to-end connector or jumper/linking cables (sold separately)
- High CRI and no glare flat lighting
- Requires the use of a 24V DC driver (sold separately)
- Compatible with Trulux controllers

Mounting

Surface mount via magnetic plate

Applications

Under-cabinets, Task Lighting, Accent lighting

Technical Information



Length	8"	16"	22"	34"
Finish	WH	WH	WH	WH
Voltage	24V DC			
CCT	3000K			
CRI	90+			
Wattage	7W	13W	19W	24W
Lumens	340Lm	675Lm	1000Lm	1200Lm
Max Run	Dependant on driver			
Beam Angle	120°			
Dimming	15-100% CL, TRIAC when using DRJ driver; 15-100% ELV when using ELV driver; 5-100% (requires Trulux control+ receiver)			
Ambient Temp	-10°C (14°F) to 40°C (104°F)			
Operating Temp	-10°C (14°F) to 70°C (158°F)			
Rating	cETLus Listed, Dry locations			
Rated Life	35,000 Hours			

Dimensions

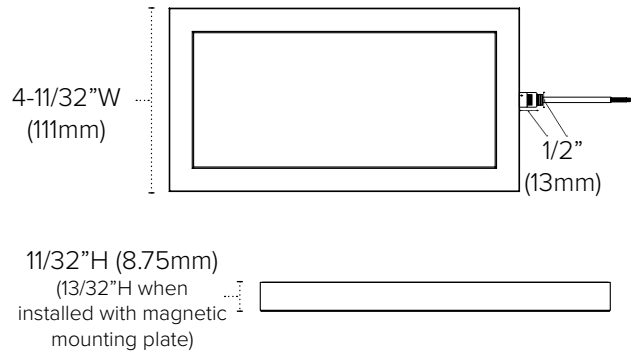

Example Trulux Controller Set-up

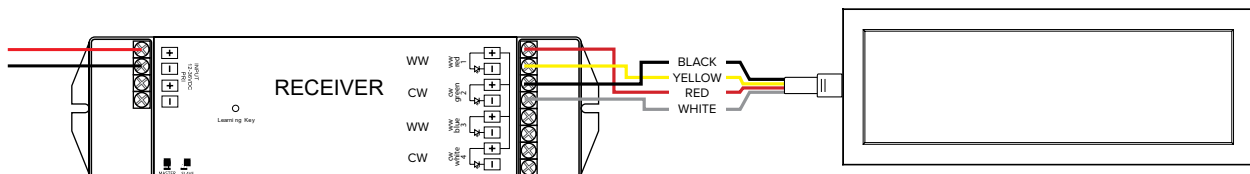
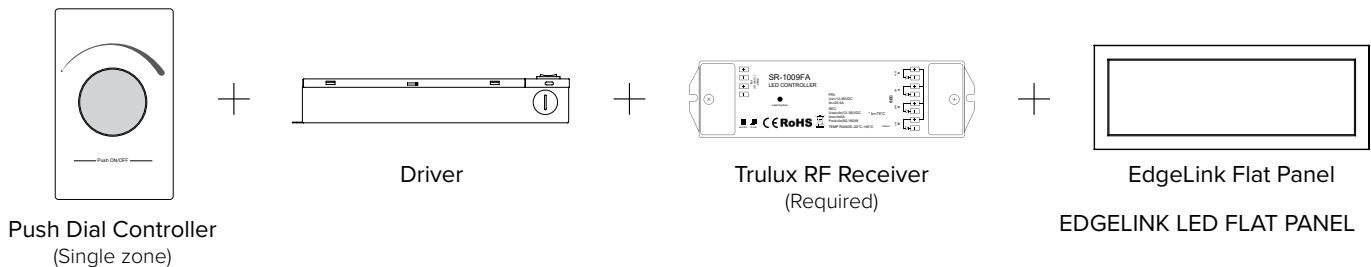

Ordering Information

24V EdgeLink LED Flat Panel

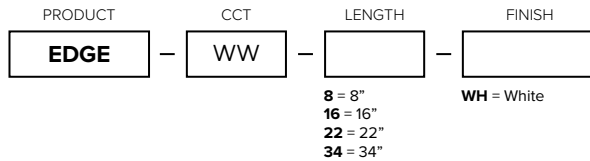



EdgeLink fixtures include:

- (1) 6' 20AWG Power Connector Wire w/ tack nails
- (1) End-to-end linking connector
- (1) Magnetic mounting plate with mounting screws

Example Part # **EDGE-WW-34-WH**



Accessories





Image	Part Number	Description
	EDGE-CONKIT12	12' 20AWG Power Connector Wire
	EDGE-EX6-WH	6" White EdgeLink extension cable (for extending remote driver distance)
	EDGE-EX12-WH	12" White EdgeLink extension cable (for extending remote driver distance)
	EDGE-EX24-WH	24" White EdgeLink extension cable (for extending remote driver distance)

RECOMMENDED POWER SUPPLIES

ITEM NUMBER	DESCRIPTION	MAX / MIN LOAD	INPUT VOLTAGE	OUTPUT VOLTAGE	DIMMABLE	DIMENSIONS
ADPT-DRJ-30-24	Adaptive Series 30W	30W / 3W	100-277V AC	24V	Yes*	6.49"L x 3.6"W x 1.02"H
ADPT-DRJ-60-24	Adaptive Series 60W	60W / 6W	100-277V AC	24V	Yes*	7.4"L x 3.6"W x 1.02"H
ADPT-DRJ-96-24	Adaptive Series 96W	96W / 9.6W	100-277V AC	24V	Yes*	8.66"L x 3.6"W x 1.61"H
ADPT-DRJ-192-24	Adaptive Series 192W (2 x 96W)	192W / 19.2W	100-277V AC	24V	Yes*	10.94"L x 4.25"W x 1.8"H
ADPT-DRJ-288-24	Adaptive Series 288W (3 x 96W)	288W / 28.8W	100-277V AC	24V	Yes*	11.85"L x 4.25"W x 1.8"H

Phase Dimming Compatible With Most MLV, ELV, and TRIAC Dimmers

Trulux Single Color Control Options

Image	Part Number	Description
Trulux Controllers		
	SRF-BATT	Trulux Single Color Radio Frequency Control; Push Dial Wall Mount; Single zone; Battery operated (CR2032 included); Requires the use of a Trulux Radio Frequency receiver
	SRF-4Z-3P	Trulux Single Color Radio Frequency Control; Touch Slider Wall Mount; 1-4 zones; 12V/24V DC input; Requires the use of a Trulux Radio Frequency receiver
	Trulux App	Trulux Mobile Application; Mobile Phone or Tablet ready, interactive dial controls; Available on Google Play or the App Store; Requires the TruHub (RF-WiFi-8) router and receivers (REC-5A-4Z) for 2-8 zones or the RF + WiFi receiver (REC-5A-4Z-WiFi) for single zone applications
Trulux Receivers		
	REC-5A-4Z	Trulux Radio Frequency Receiver; Sync multiple receivers to a single control; 4 x (60-180W) 5A per channel; 12V/24V DC input; For use with Trulux Radio Frequency control or Trulux TruHub plus Trulux App
	REC-5A-4Z-WIFI	Trulux Radio Frequency + WiFi Receiver; Sync multiple receivers to a single control; 4 x (60-180W) 5A per channel; 12V/24V DC input; For use with Trulux Radio Frequency Control or Trulux App
	WIFI-RF-8	TruHub WiFi Hub Control; converts WiFi to RF for 2-8 zones; For use with REC-5A-4Z and Trulux App