

PROJECT:  TYPE:

LOCATION:  CAT:



DARK BRONZE - STAINLESS STEEL - WHITE

### Description

Easy to install indoor/outdoor LED Step Lights install into most standard depth, single gang junction boxes.

### Features

- LED light engine in 3000K Warm White
- Multiple faceplate styles in three finishes (sold separately)
- Heavy duty plastic light module with white acrylic lens
- Durable cast zinc-magnesium faceplate with powder coated painted finish for White and Dark Bronze finishes, plated for Brushed Steel
- Sealed light engine is rated for wet locations (IP65)
- 7" 18AWG lead wires
- Connect sets of SGL step lights to a branch circuit and use a wall switch for On/Off control

### Mounting

Install into most standard depth, single gang junction boxes (includes watertight gasket)

### Applications

Architectural lighting, stairs, gardens, sidewalk paths



## Technical Information

Voltage	120-277V AC, 60Hz
CCT	3000K
Wattage	1.7W
Lumens	16-81lm (varies by faceplate used)
CRI/nm	82+ CRI
Dimming	N/A
Rating	cULus, Indoor/Outdoor, Wet locations
Rated Life	50,000 Hours

### Dimensions (LED Light engine only)

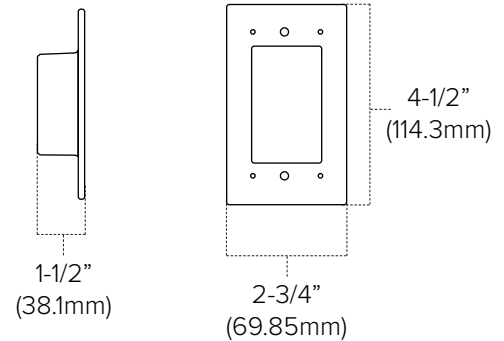

## Ordering Information

**SGL3 Step Light**  
**120-277V,**  
**60Hz AC**

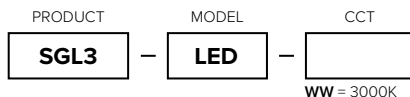

### SGL3 Indoor/Outdoor Step Lights Include:

- (1) SGL3 LED Light Engine
- (1) Watertight gasket for single gang junction box





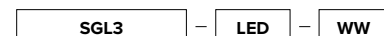





Requires SGL Step Light faceplate (sold separately; see accessories on next page)

Example Part # **SGL3-LED-WW**





## Accessories

Image	Part Number	Description
	SGL-SM-DB	Smooth Lens Faceplate in Dark Bronze finish for SGL Step Light; aluminum alloy; 2-15/16"W x 4-3/4"H x 3/8"D
	SGL-SM-SS	Smooth Lens Faceplate in Stainless Steel finish for SGL Step Light; aluminum alloy; 2-15/16"W x 4-3/4"H x 3/8"D
	SGL-SM-WH	Smooth Lens Faceplate in White finish for SGL Step Light; aluminum alloy; 2-15/16"W x 4-3/4"H x 3/8"D
	SGL-VL-WH	Vertical Louver Faceplate in White finish for SGL Step Light; aluminum alloy; 2-15/16"W x 4-3/4"H x 3/8"D
	SGL-VS-SS	Vertical Scoop Faceplate in Stainless Steel finish for SGL Step Light; aluminum alloy; 2-15/16"W x 4-3/4"H x 1-1/16"D
	SGL-HW-DB	Horizontal Wave Faceplate in Dark Bronze finish for SGL Step Light; aluminum alloy; 4-3/4"W x 2-15/16"H x 3/8"D
	SGL-HW-SS	Horizontal Wave Faceplate in Stainless Steel finish for SGL Step Light; aluminum alloy; 4-3/4"W x 2-15/16"H x 3/8"D
	SGL-HW-WH	Horizontal Wave Faceplate in White finish for SGL Step Light; aluminum alloy; 4-3/4"W x 2-15/16"H x 3/8"D
	SGL-HL-DB	Horizontal Louver Faceplate in Dark Bronze finish for SGL Step Light; aluminum alloy; 4-3/4"W x 2-15/16"H x 3/8"D
	SGL-HL-SS	Horizontal Louver Faceplate in Stainless Steel finish for SGL Step Light; aluminum alloy; 4-3/4"W x 2-15/16"H x 3/8"D
	SGL-HL-WH	Horizontal Louver Faceplate in White finish for SGL Step Light; aluminum alloy; 4-3/4"W x 2-15/16"H x 3/8"D

## Additional Information

Model	Mounting	Location
SGL3-LED	Direct mount to standard depth single gang junction box	Indoor/Outdoor; Wet location

## NOTES

---



---



---



---



---