

PROJECT: TYPE:

LOCATION: CAT:



Description

The Universal extrusion can be surface or recess mounted for most applications.

Features

- Extruded aluminum construction
- Can be mounted face down for use as a heat sink
- Use tape light, lens, and end caps to create a complete fixture (tape light and accessories sold separately)

Mounting

Surface or recess mount via mounting clips, construction adhesive, or 3M® double-sided adhesive tape; Requires 1/2" height/depth clearance

Applications

Surface or recessed application including under shelves or cabinets

Warranty

3 years

Technical Information

Profile Dimensions

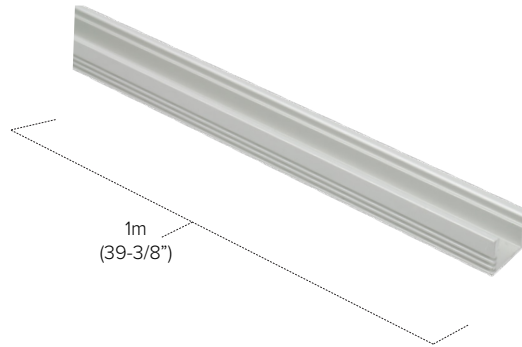
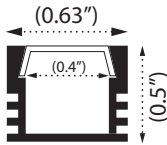



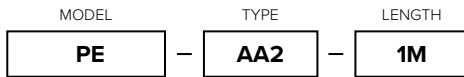

Ordering Information

Universal Extrusion



PE-AA2-1M includes:
(1) 1M Universal extrusion

Accessories

Image	Part Number	Description
	PE-UVLENS-1M	1 meter frosted polycarbonate lens for Universal extrusion; UV Resistant/Flame Retardant
	PE-FOCLENS-1M	1 meter clear polycarbonate 10° focus lens for Universal extrusion
	PE-AA2-END	Polypropylene plastic end cap for Universal extrusion
	E-CLIP	Aluminum mounting clip for Universal extrusion
	3M-TAPE-10	1/2" x 4" Length Strips of 3M® double-sided adhesive tape (Bag of 10)